

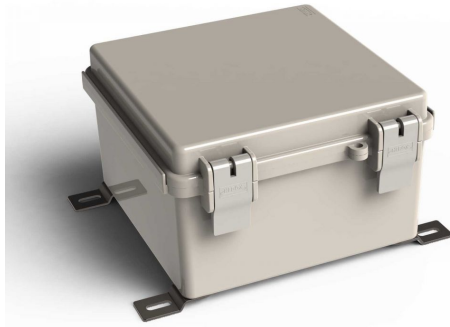

Field Considerations

John R. Leeman
GEARS 2023

Making instruments in the lab is great, but there are many factors to consider when deploying the instrument

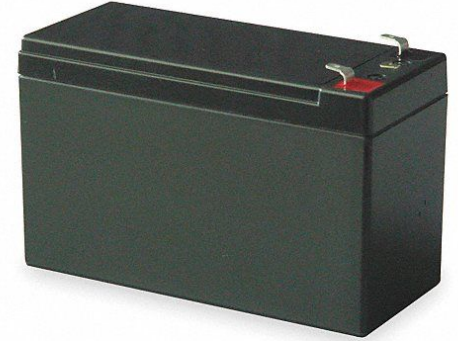
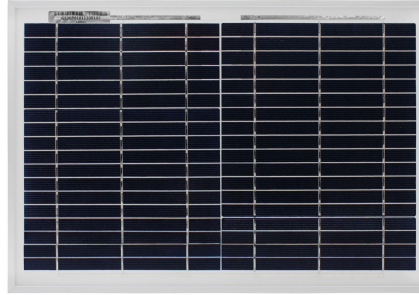

Batteries are very application specific and environment sensitive

Primary

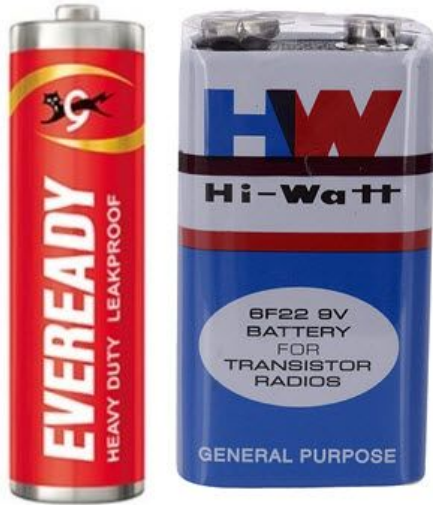

Secondary

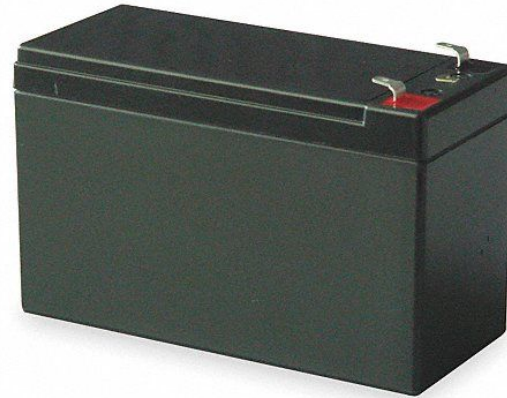

Some key things to consider when looking for batteries

- Size
- Weight
- Power Density
- Price
- Voltage
- Recharge Requirements
- Recharge Gasses/Sensitivity

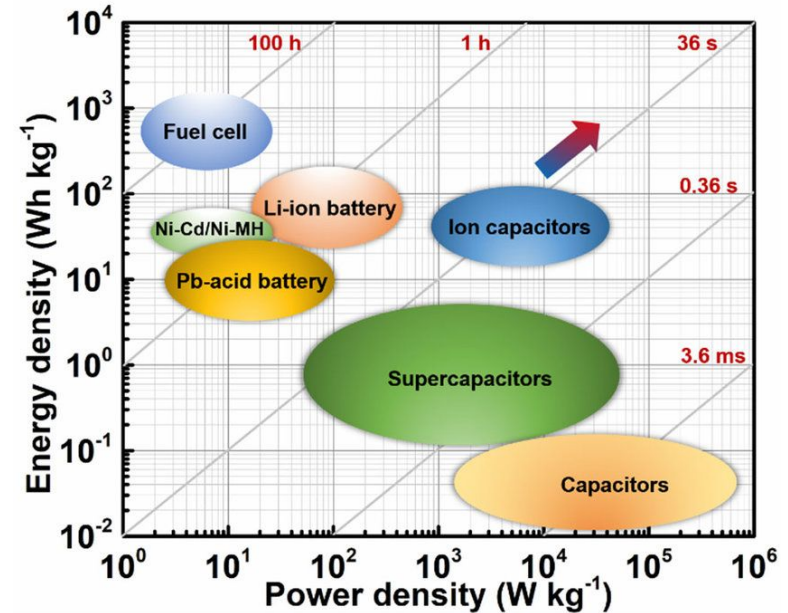

Batteries are rated in Ah and have unique discharge characteristics

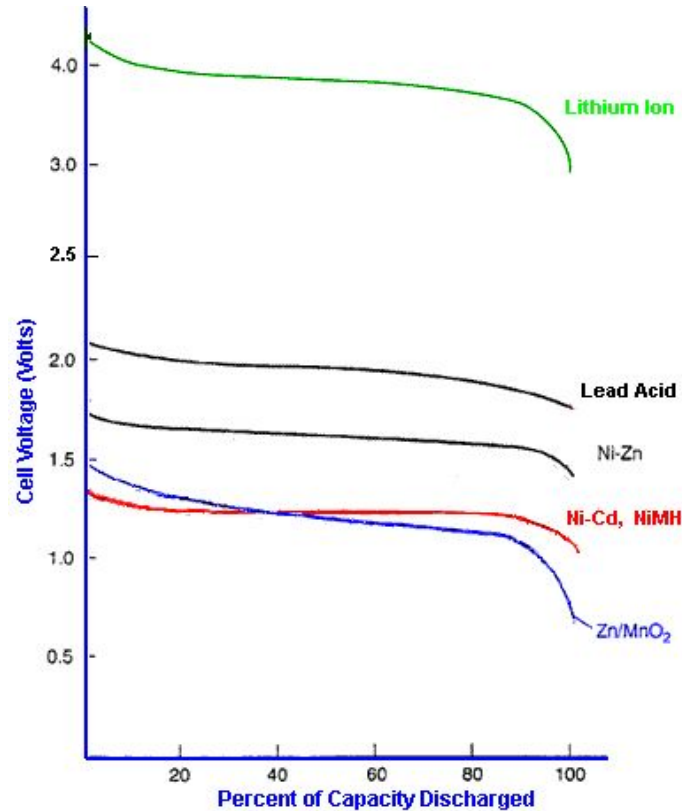

Power capability measured in C's

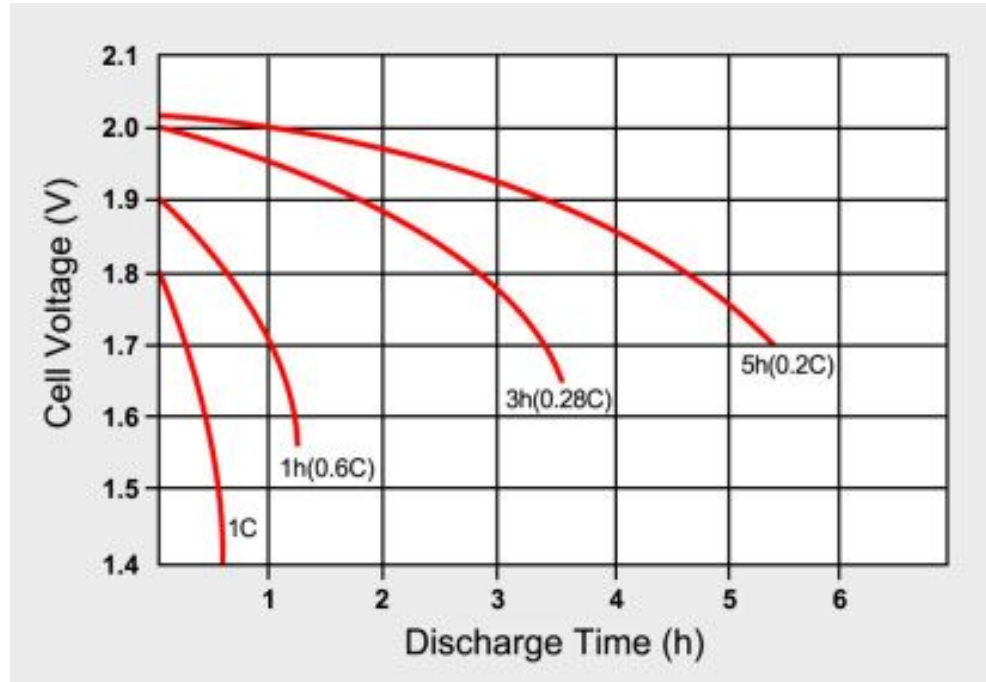

Self discharge and temperature are important factors for long term deployments of battery powered systems

Battery chemistry	Rechargeable	Typical self-discharge or shelf life
Lithium metal	No	10 years shelf life ^[3]
Alkaline	No	5 years shelf life ^[3]
Zinc-carbon	No	2-3 years shelf life ^[3]
Lithium-ion	Yes	2-3% per month; ^[3] ca. 4% p.m. ^[4]
Lithium-polymer	Yes	~5% per month ^[5] <i>[better source needed]</i>
Low self-discharge NiMH	Yes	As low as 0.25% per month ^[6]
Lead-acid	Yes	4-6% per month ^[3]
Nickel-cadmium	Yes	15-20% per month ^[3]
Nickel-metal hydride (NiMH)	Yes	30% per month ^[3]

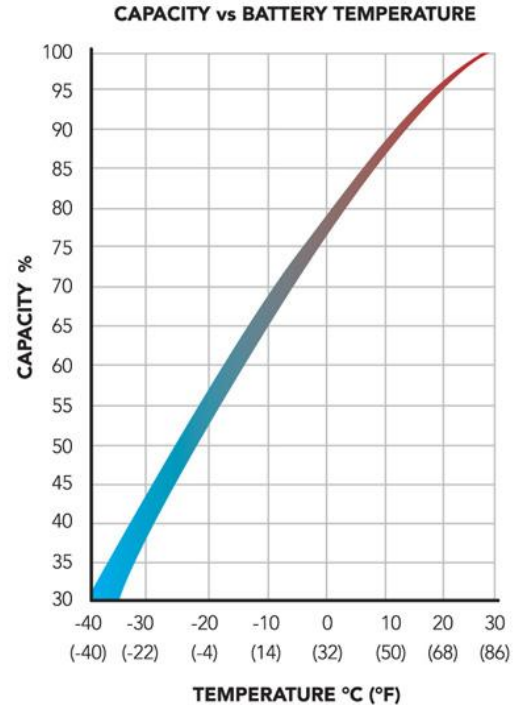

Batteries also vary their capacity and characteristics with discharge rate

Industry Reference	Voltage	Nominal Capacity Ampere Hours @ 25° C (77° F) to 1.75 Volts per cell									Length		Width		Height		Weight	
		1 Hour Rate	2 Hour Rate	4 Hour Rate	8 Hour Rate	24 Hour Rate	48 Hour Rate	72 Hour Rate	100 Hour Rate	120 Hour Rate	in	mm	in	mm	in	mm	Lbs	Kg
Group 31	12v	79 Ah	100 Ah	103 Ah	113 Ah	129 Ah	139 Ah	144 Ah	146 Ah	149 Ah	12.90	328	6.75	171	8.96	228	75	34.0

Lead acid batteries are a common choice with lots of permutations for secondary battery needs



- Inexpensive
- High Capacity
- High Discharge Rates



- Low Power Density
- Heavy
- Temperature Performance



Alkaline batteries are the most common of the primary batteries



- Easy to get (popular)
- Safe
- Well known
- Long Shelf Life
- 100 Wh/kg density



- Low capacity
- Non-rechargeable



NiCad is an older technology, but one still in use



- Inexpensive
- Standard Sizes
- Easy to recharge
- Low self discharge



- Low power density
- Memory effects
- Toxic metals



NiMH can be a good NiCAD replacement in some situations



- Somewhat Inexpensive
- Standard Sizes
- Somewhat easy to recharge
- High power density
- Better capacity than alkaline



- High self discharge
- Shorter service life



Li-Ion and LiPoly are common, but not always the best solution for field instruments



- Very light
- High power
- High capability
- High cell voltage



- Expensive
- Delicate
- Fire is the failure mode
- Hard to charge
- Poor temperature performance

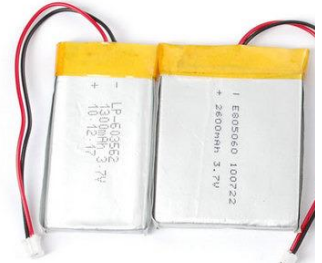

Lithium primary batteries are becoming common for single use deployment batteries



- Very light
- High density
- High cell voltage
- High shelf life



- Non-rechargeable
- Low current capability
- Odd sizes



If you are using a secondary battery consider solar charging and careful power budgeting

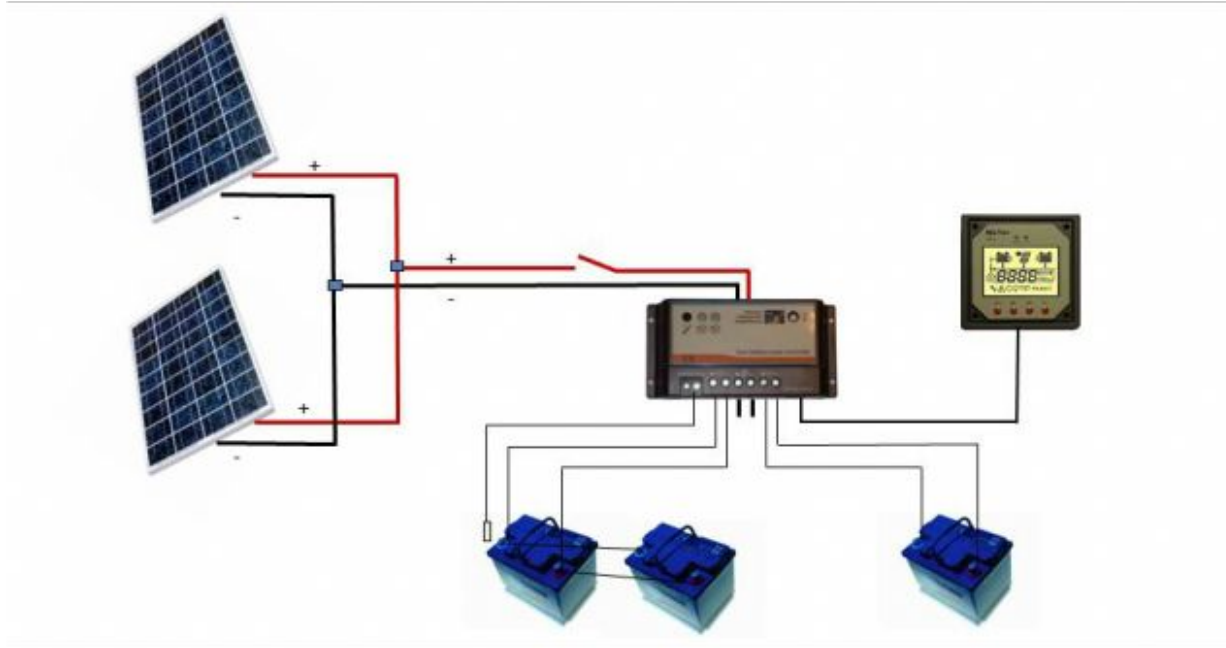

Enclosures are a whole other topic, but a few factors to consider

- Don't reinvent the wheel
- Case pressure equalization
- Case condensation
- Gas buildup
- Greenhouse effect/internal temperature
- Camouflage

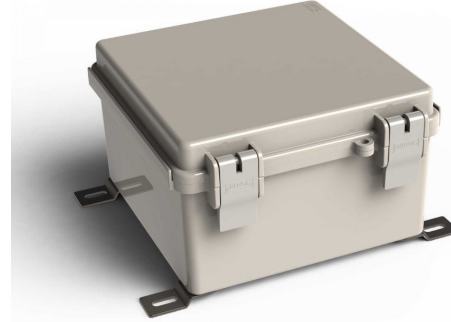
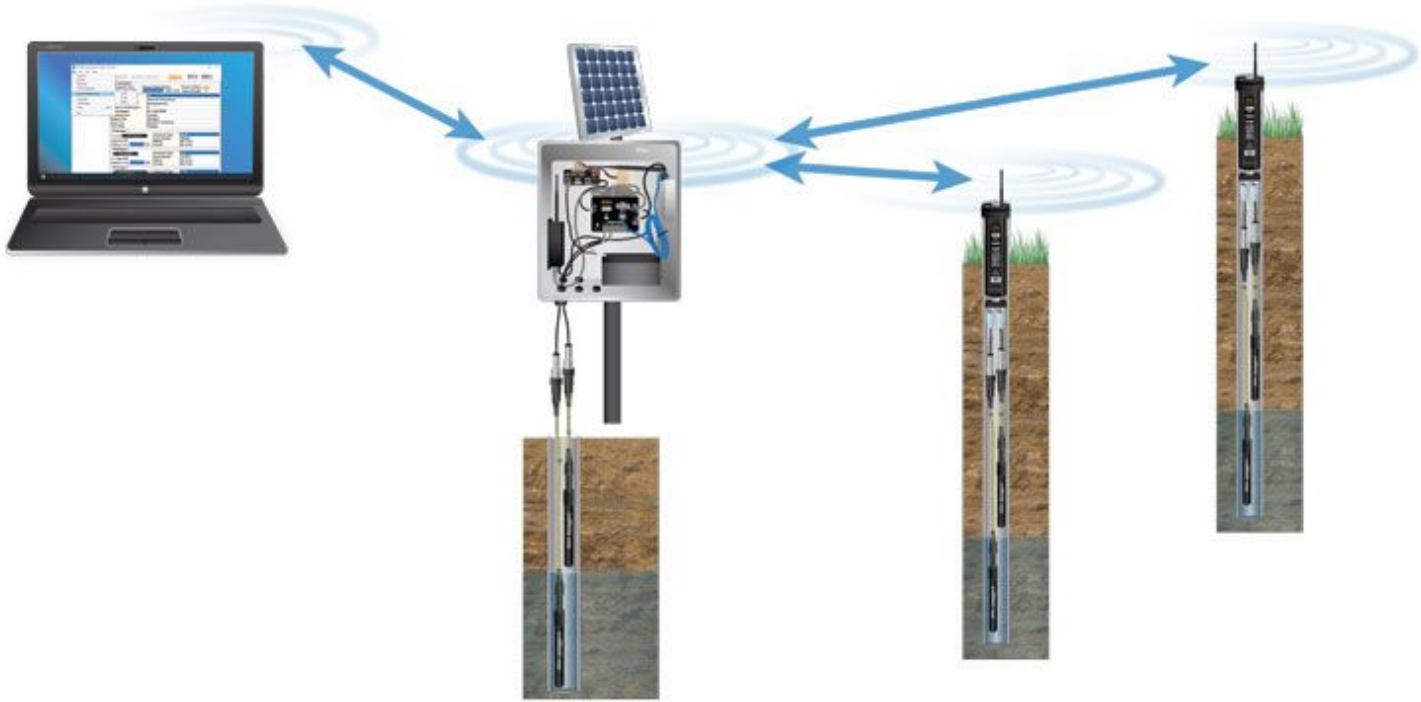
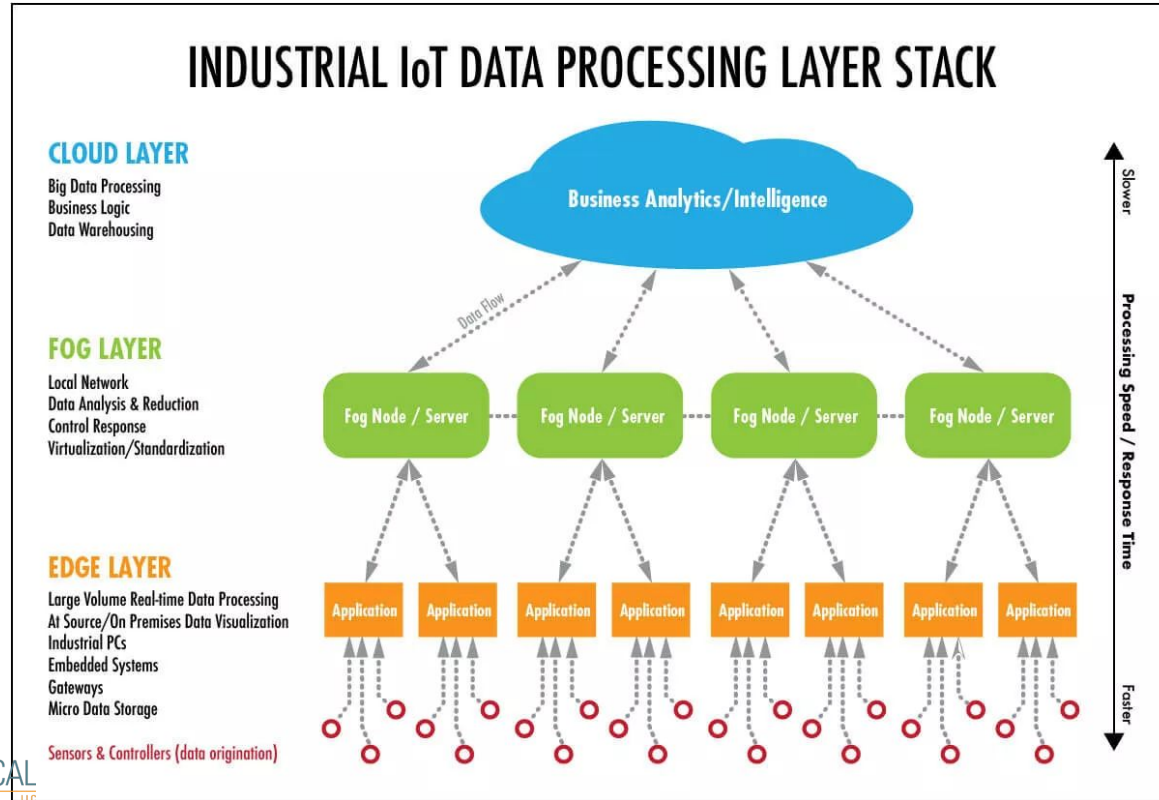

Image: Polycase, Nanuk

Telemetry or getting your data back can be very beneficial compared to local storage



Generally the goal is to get to the internet for cloud computing or storage of the data. Local data centers are for larger projects.



Wired/serial connections to a computer are the easiest, fastest, and most reliable connections for telemetry

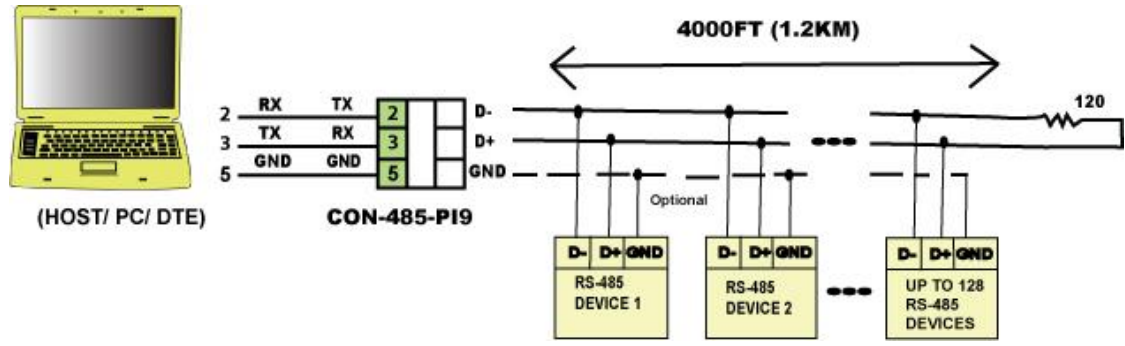

WiFi is becoming more ubiquitous, but can get expensive

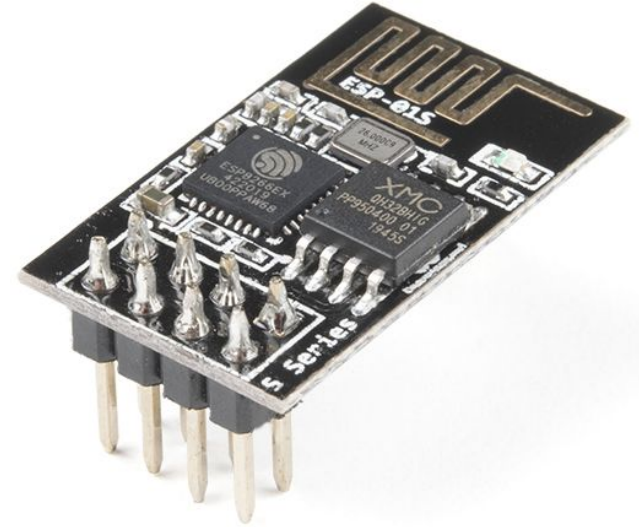

Xbee is a mid-range radio link that can get data in from a small field area to a telemetry node. They have mesh capabilities

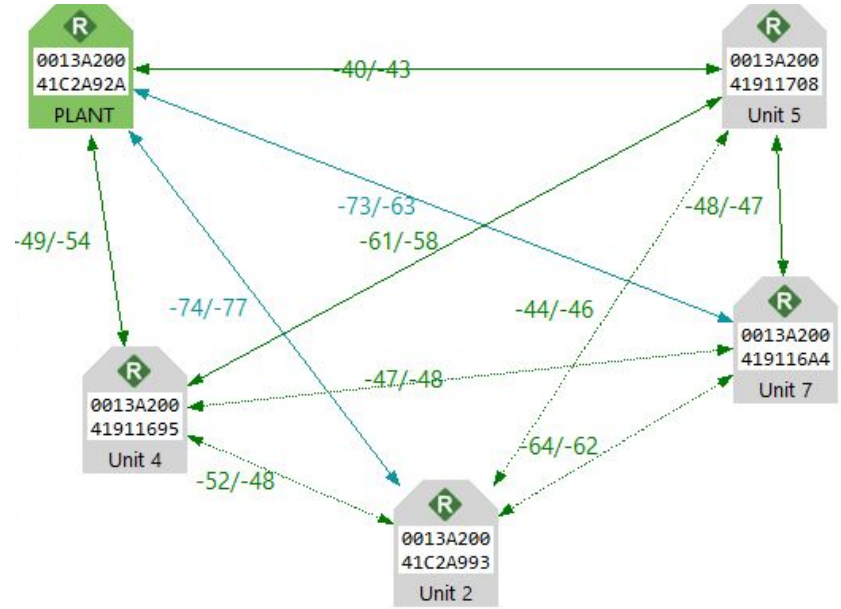

LoRa/LoRaWAN are emerging, but limited to low data rates

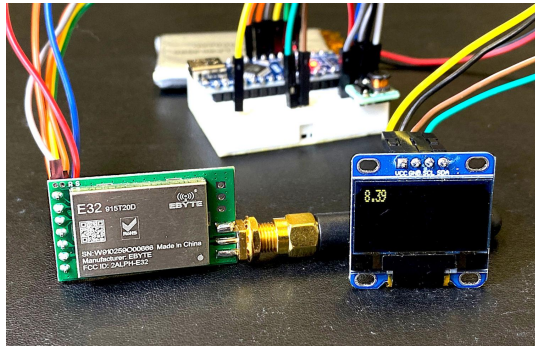
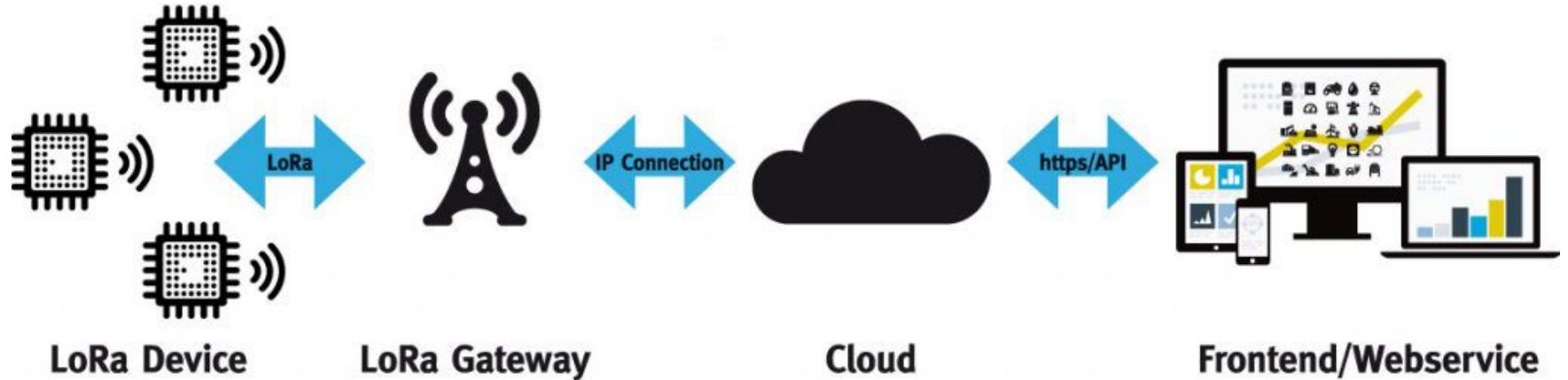

Understanding the Limits of LoRaWAN

Ferran Adelantado, Xavier Vilajosana, Pere Tuset-Peiro, Borja Martinez, Joan Melià-Seguí, Thomas Watteyne.

ABSTRACT

Low-Power Wide Area Networking (LPWAN) technology offers long-range communication, which enables new types of services. Several solutions exist; LoRaWAN is arguably the most adopted. It promises ubiquitous connectivity in outdoor IoT applications, while keeping network structures, and management, simple. This technology has received a lot of attention in recent months from network operators and solution providers. Yet, the technology has limitations that need to be clearly understood to avoid inflated expectations and disillusionment. This article provides an impartial and fair overview of what the capabilities and the limitations of LoRaWAN are. We discuss those in the context of use cases, and list open research and development questions.

LoRaWAN technology in details. Section IV analyzes the network capacity and scale limitations of the technology. Section V discusses the use cases where LoRaWAN works/doesn't work. Section VI lists open research and development challenges for the technology. Section VII concludes.

II. OVERVIEW OF LPWAN AND CELLULAR TECHNOLOGIES FOR IOT

A. Low-Power Wide-Area Alternatives

Although LoRaWAN is one of the most adopted technologies for IoT, there is a wide range of LPWAN technologies in the market, such as Ingenu, Weightless W, N and P or SigFox [8].

Image: Microtronics, MakerPortal

Bluetooth isn't common for field devices other than for setup, but can be used in very small networks

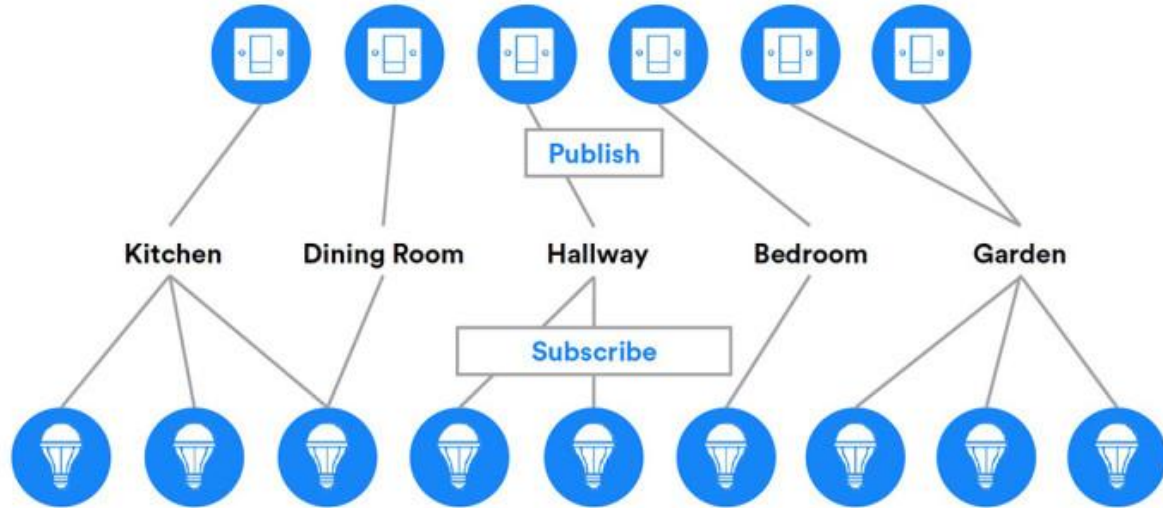
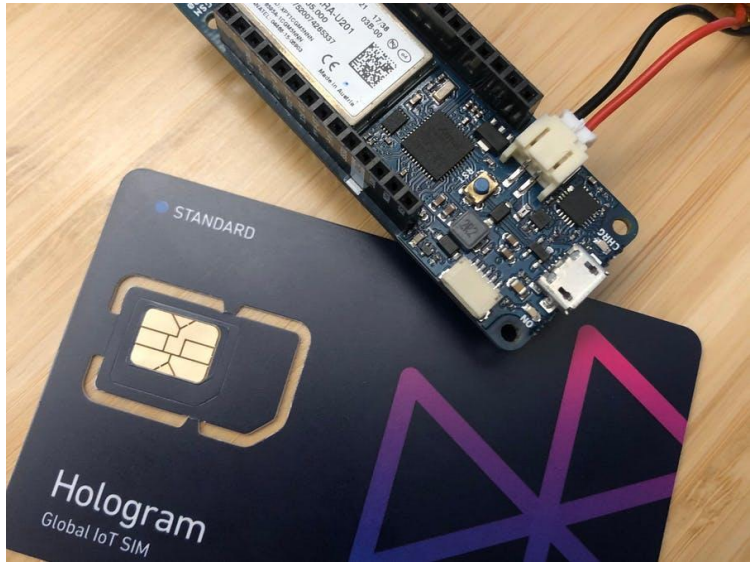
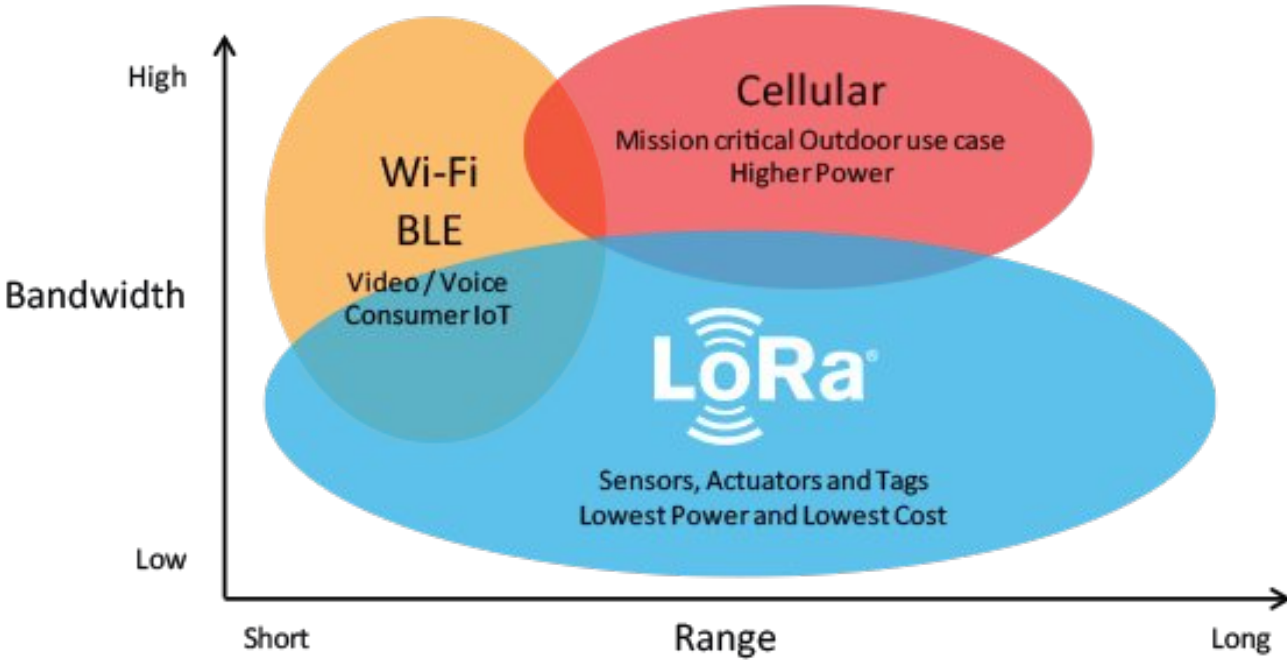

Figure 4 - Publish/Subscribe

Cell modems are becoming inexpensive as long as coverage is available and the project is ground based



As always these main three methods have a tradeoff space



Finally satellite data can be the easiest, but most expensive solution

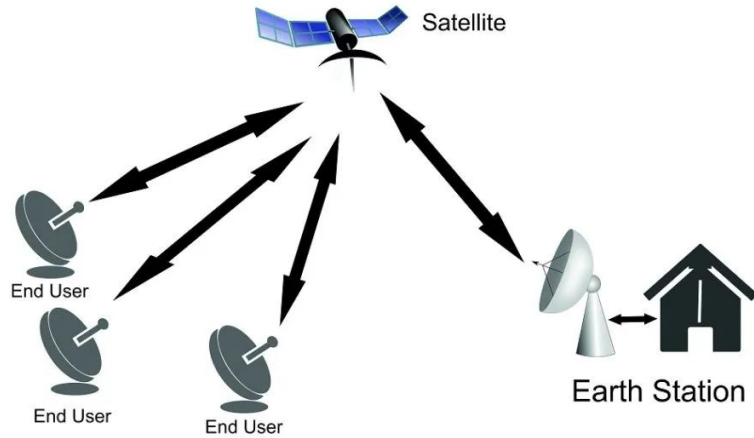

VSAT Communication System



Image: CFI, Iridium Communications

The key to any system is to plan the entire stack and data management system well in advance

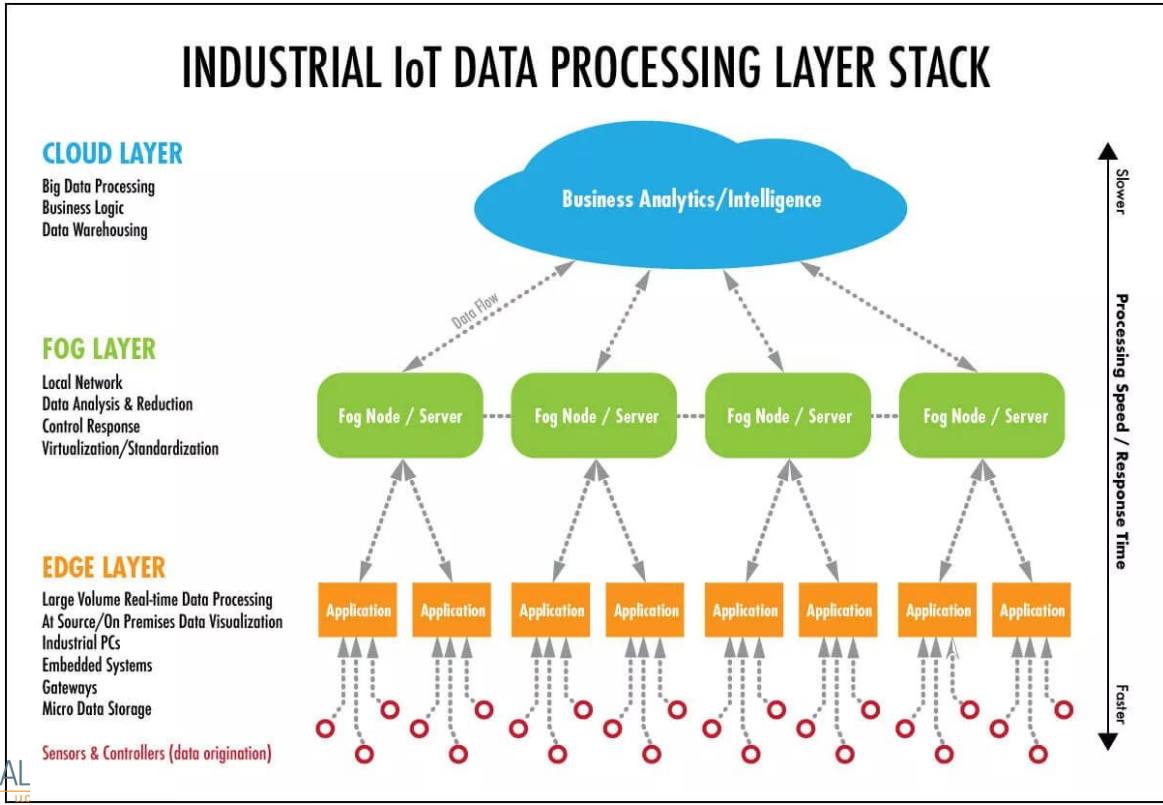

We use AWS to house data produced and telemetered by many of these methods

- 300534060707730_20210703.txt
- 300534060707730_20210704.txt
- 300534060707730_20210705.txt
- 300534060707730_20210706.txt
- 300534060707730_20210707.txt
- 300534060707730_20210708.txt
- 300534060707730_20210710.txt
- 300534060707730_20210711.txt
- 300534060707730_20210712.txt
- 300534060707730_20210713.txt
- 300534060707730_20210714.txt
- 300534060707730_20210715.txt
- 300534060707730_20210716.txt

