

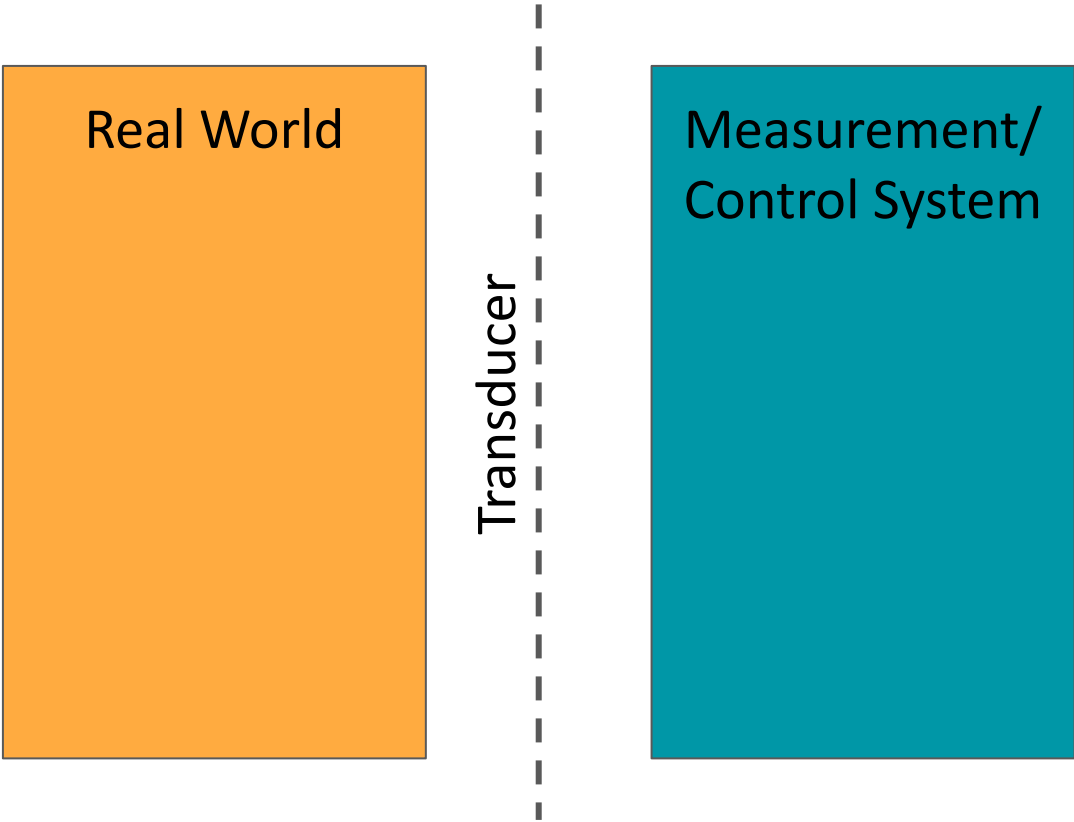

Sensors, Transducers, and Actuators

John R. Leeman
GEARS 2022

Transducers convert one form of energy into another



We classify transducers into three distinct types based on “direction”

Sensors



Actuators



Bidirectional



Transducers can be active or passive in nature



Images: Transtek, Digikey, Amazon, Futek

A few of the MANY factors to consider when looking for transducers



- Range
- Span
- Linearity
- Sensitivity
- Response Time
- Stability
- Accuracy
- Noise
- Durability/Environmental
- Cost
- Signal Conditioning
- Technology
- Hysteresis
- Output

Range is the values over which the transducer is rated to perform

SPECIFICATIONS - ELECTRICAL



MODEL NUMBER	0240-0000	0241-0000	0242-0000	0243-0000	0244-0000	0245-0000	0246-0000	0246-00005	
WORKING RANGE, ± Inches (mm)	0.050 (1.27)	0.100 (2.54)	0.250 (6.35)	0.500 (12.7)	1.00 (25.4)	2.00 (50.8)	3.00 (76.2)	3.00 (76.2)	
MAX. USABLE RANGE, ± Inches (mm)	0.075 (1.78)	0.150 (3.75)	0.375 (9.53)	0.750 (19.1)	1.50 (38.1)	2.75 (69.8)	3.25 (82.5)	4.00 (101)	
INPUT, VDC	6.0 Min. to 30 Max.							9.0 Min. to 30 Max.	
NOMINAL F.S. OUTPUT, ±VDC with unloaded output									
@ 6 VOLT INPUT	1.3	2.4	1.8	3.1	4.6	3.9	3.3	N/A	
@ 15 VOLT INPUT	3.4	6.4	4.8	8.3	12.1	10.2	8.7	10	
@ 24 VOLT INPUT	5.5	10.4	7.8	13.5	18.7	16.5	14.1	16.3	
@ 30 VOLT INPUT	7.0	13.0	9.7	17.0	24.8	20.7	17.7	30.5	
INPUT CURRENT	8.3 mA @ 6 Volt input to 52 mA @ 30 Volt input								
² NON-LINEARITY	±0.5% Full Scale Over Total Working Range, ±1.0% Full Scale Over Maximum Usable Range								
INTERNAL CARRIER FREQUENCY, Hz	13000	12000	3600	3400	3200	1500	1400	1400	
% RIPPLE, RMS (nominal)	0.7	0.7	0.8	0.8	0.8	1	1	1	
OUTPUT IMPEDANCE, Ohms	2500	3500	5200	5500	5600	5500	5600	5600	
FREQ. RESPONSE (3 dB down), Hz	300	140	115	110	100	110	75	75	
TEMPERATURE RANGE	-65°F to +250°F (-54°C to +121°C)								
RESOLUTION	Infinite								

Dynamic range is the ratio of the largest to smallest input measured

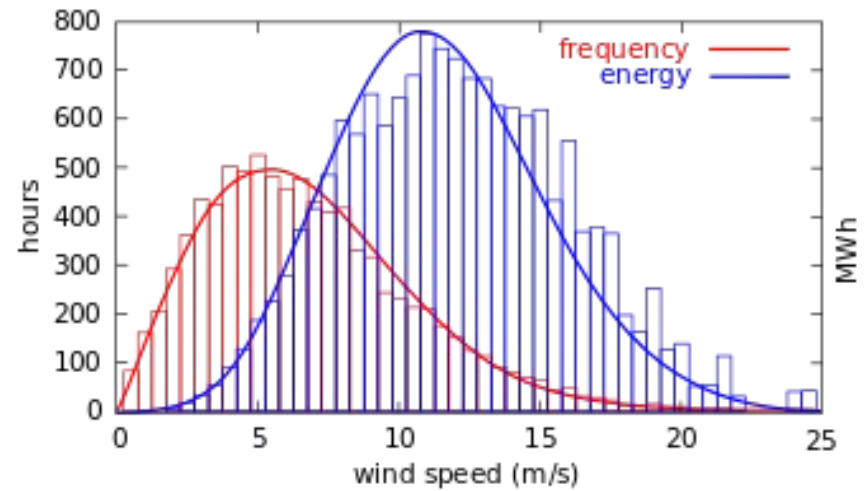
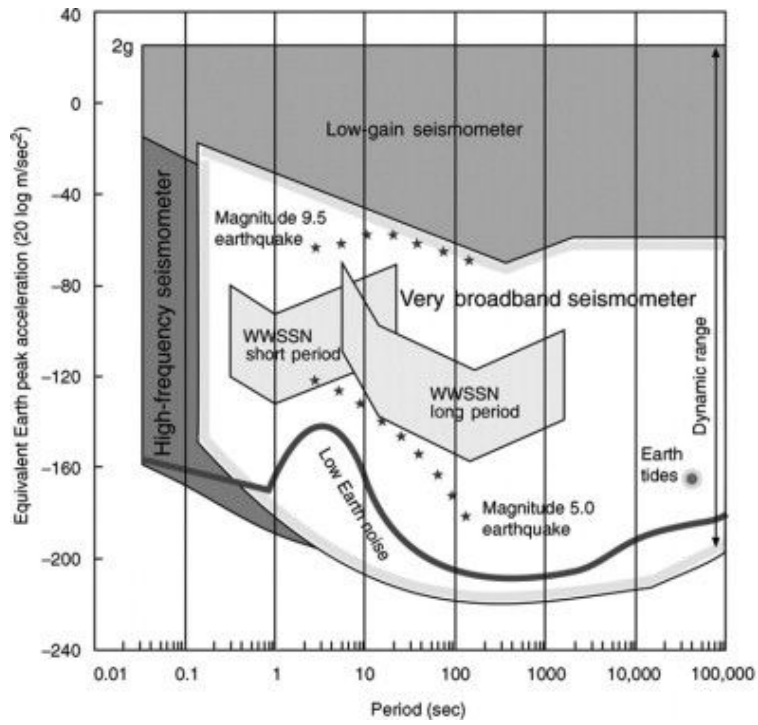

Span is the output difference at the maximum and minimum values

SPECIFICATIONS - ELECTRICAL



MODEL NUMBER	0240-0000	0241-0000	0242-0000	0243-0000	0244-0000	0245-0000	0246-0000	0246-00005	
WORKING RANGE, ± Inches (mm)	0.050 (1.27)	0.100 (2.54)	0.250 (6.35)	0.500 (12.7)	1.00 (25.4)	2.00 (50.8)	3.00 (76.2)	3.00 (76.2)	
MAX. USABLE RANGE, ± Inches (mm)	0.075 (1.78)	0.150 (3.75)	0.375 (9.53)	0.750 (19.1)	1.50 (38.1)	2.75 (69.8)	3.25 (82.5)	4.00 (101)	
INPUT, VDC	6.0 Min. to 30 Max.							9.0 Min. to 30 Max.	
NOMINAL F.S. OUTPUT, ±VDC with unloaded output									
@ 6 VOLT INPUT	1.3	2.4	1.8	3.1	4.6	3.9	3.3	N/A	
@ 15 VOLT INPUT	3.4	6.4	4.8	8.3	12.1	10.2	8.7	10	
@ 24 VOLT INPUT	5.5	10.4	7.8	13.5	18.7	16.5	14.1	16.3	
@ 30 VOLT INPUT	7.0	13.0	9.7	17.0	24.8	20.7	17.7	30.5	
INPUT CURRENT	8.3 mA @ 6 Volt input to 52 mA @ 30 Volt input								
² NON-LINEARITY	±0.5% Full Scale Over Total Working Range, ±1.0% Full Scale Over Maximum Usable Range								
INTERNAL CARRIER FREQUENCY, Hz	13000	12000	3600	3400	3200	1500	1400	1400	
% RIPPLE, RMS (nominal)	0.7	0.7	0.8	0.8	0.8	1	1	1	
OUTPUT IMPEDANCE, Ohms	2500	3500	5200	5500	5600	5500	5600	5600	
FREQ. RESPONSE (3 dB down), Hz	300	140	115	110	100	110	75	75	
TEMPERATURE RANGE	-65°F to +250°F (-54°C to +121°C)								
RESOLUTION	Infinite								

Linearity is deviation from an ideal linear output

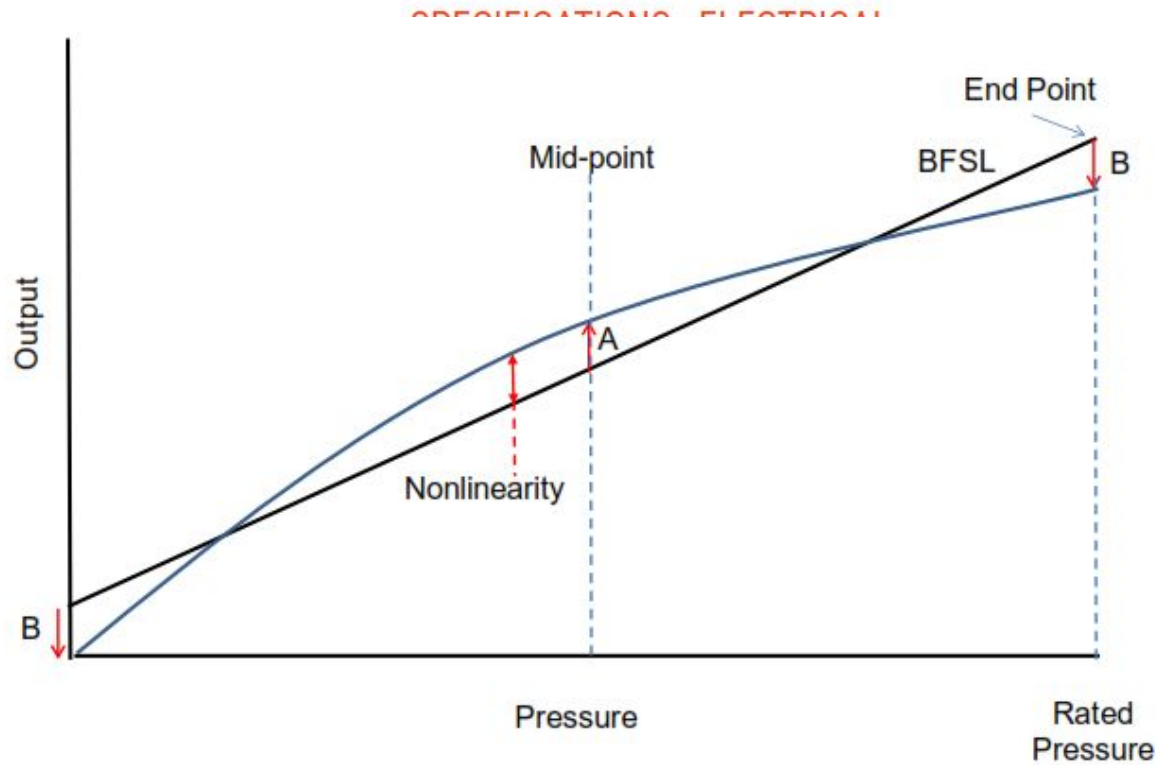

245-1000	0246-0000	0246-00005
2.00 (50.8)	3.00 (76.2)	3.00 (76.2)
2.75 (69.8)	3.25 (82.5)	4.00 (101)
		9.0 Min. to 30 Max.
3.9	3.3	N/A
10.2	8.7	10
16.5	14.1	16.3
20.7	17.7	30.5
folt input		
Over Maximum Usable Range		
500	1400	1400
1	1	1
500	5600	5600
110	75	75
C)		
RESOLUTION	Infinite	

There is also a frequency component “dynamic linearity”

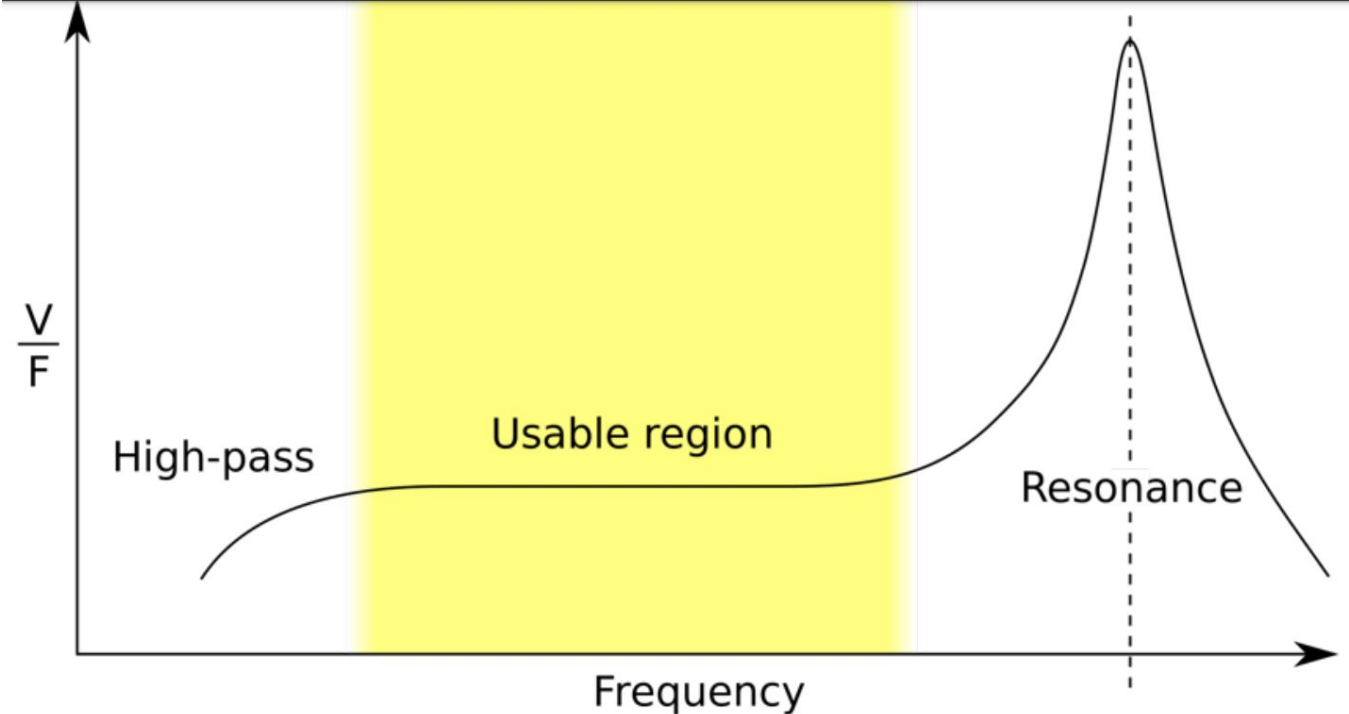

Sensitivity is the slope of the input-output curve (calibration slope)

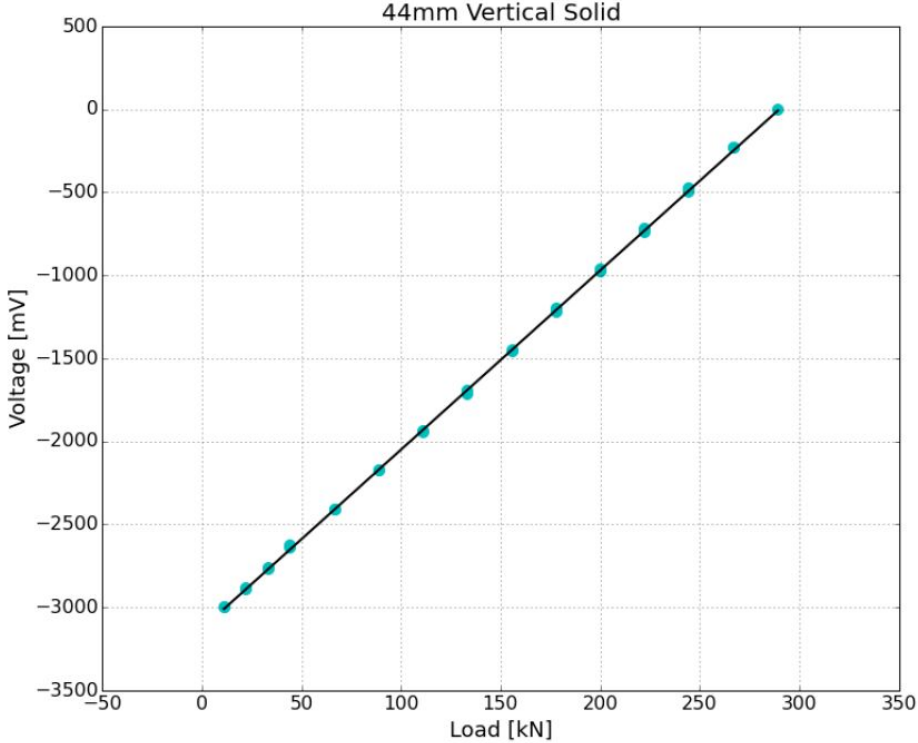

Response time must be much smaller than the timescale of the phenomena you want to measure (or it can be your low pass filter)!

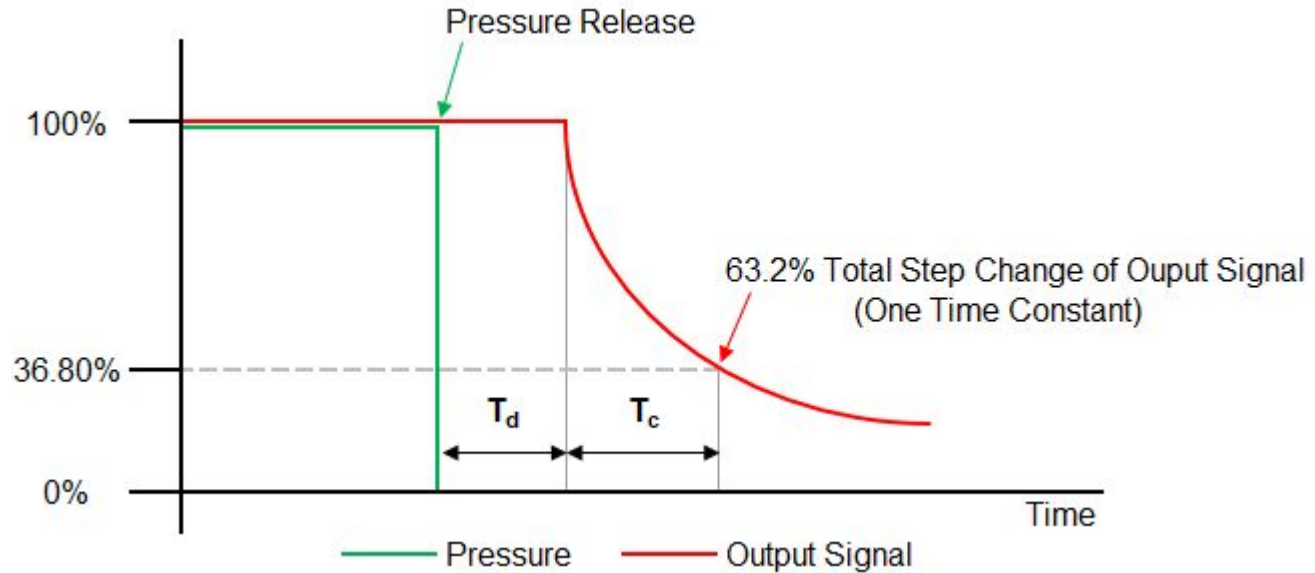

Stability is how constant the output of a transducer is when the physical stimulus is static (drift, environmental, and more)

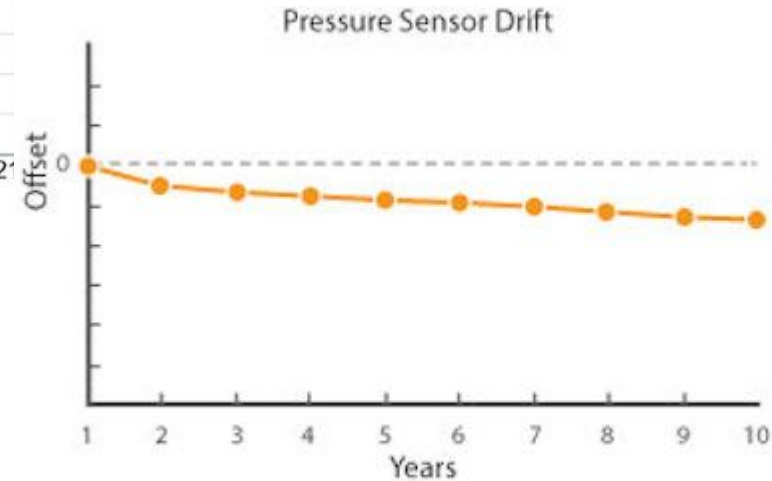
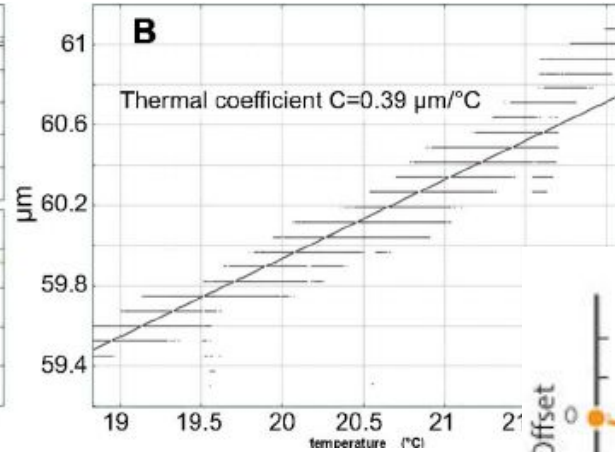
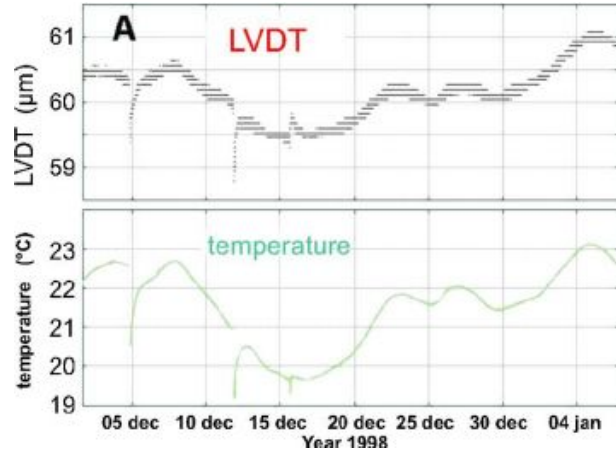

Accuracy represents the maximum difference between the real and indicated values (commonly offsets, not always constant though)

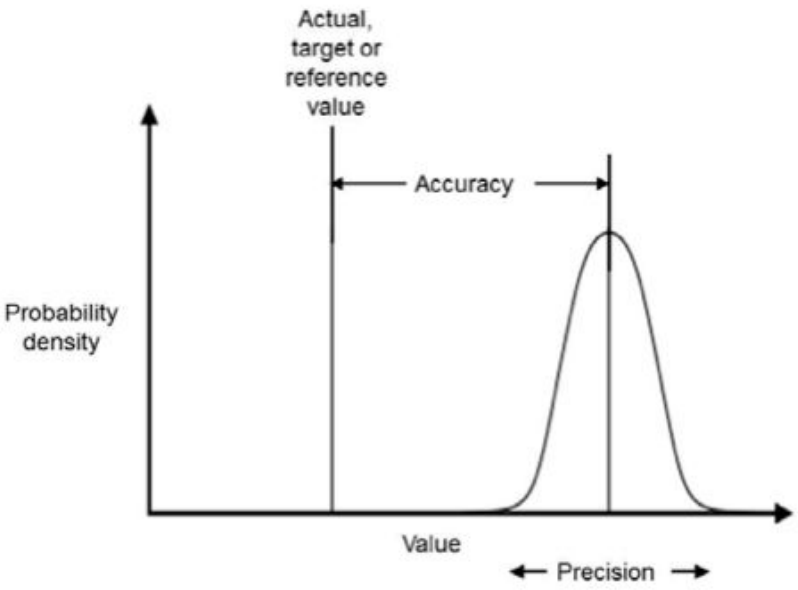

Noise is how much variation there is relation to the real signal and is related to the precision of the instrument (often SNR)

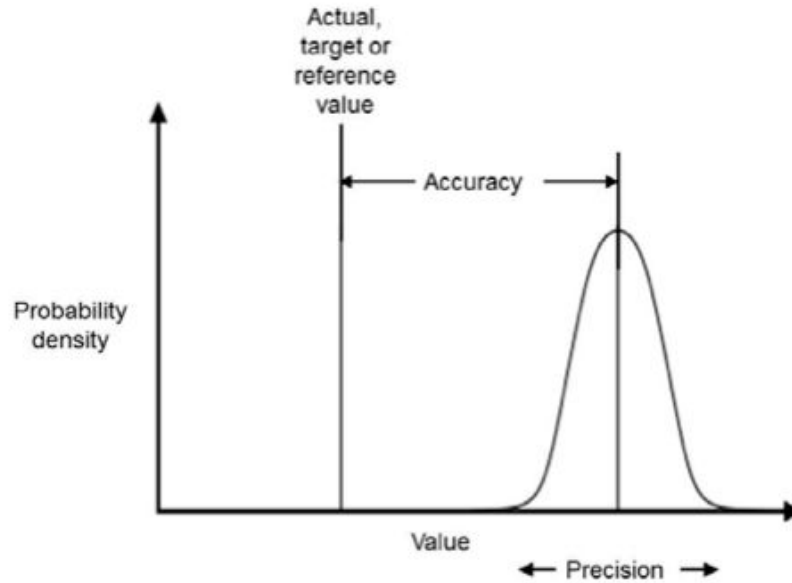

The sensor must be matched to the environment in which it will operate - and overrated generally



Cost is always a factor - can you afford it, are you going to get it back, is it more than you really need?



Signal conditioning can add more cost than the instrument and create more environmental concerns

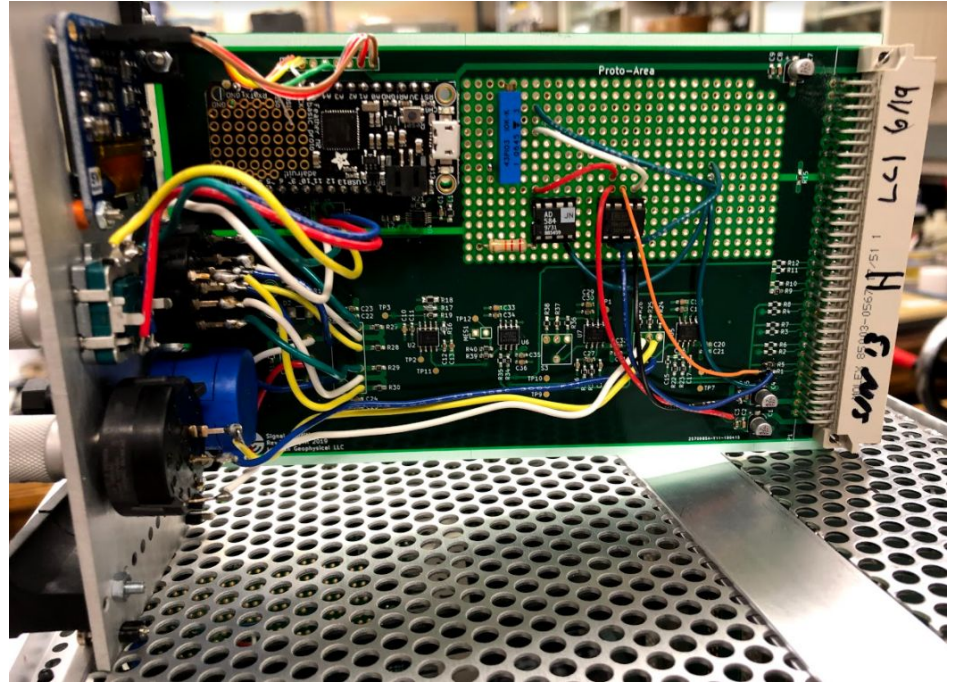

Technology used can present significant pros and cons based on your particular application



- What is the physical method
- What are the cross-sensitivities
- How stable is it
- How experimental is it

Transducer hysteresis is analogous to mechanical backlash and may or may not matter to you

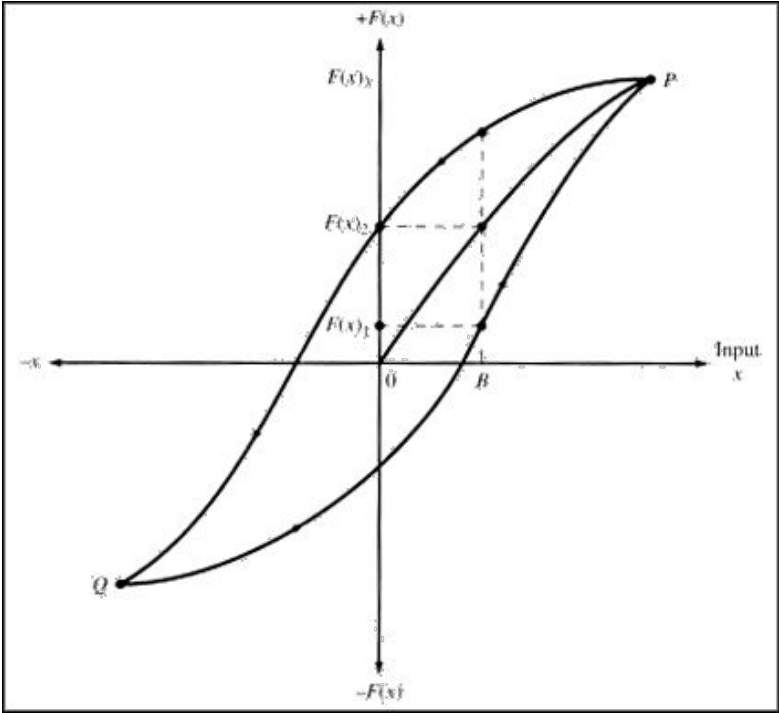

Output should be matched to your system if possible

How a 4-20mA Transmitter Works

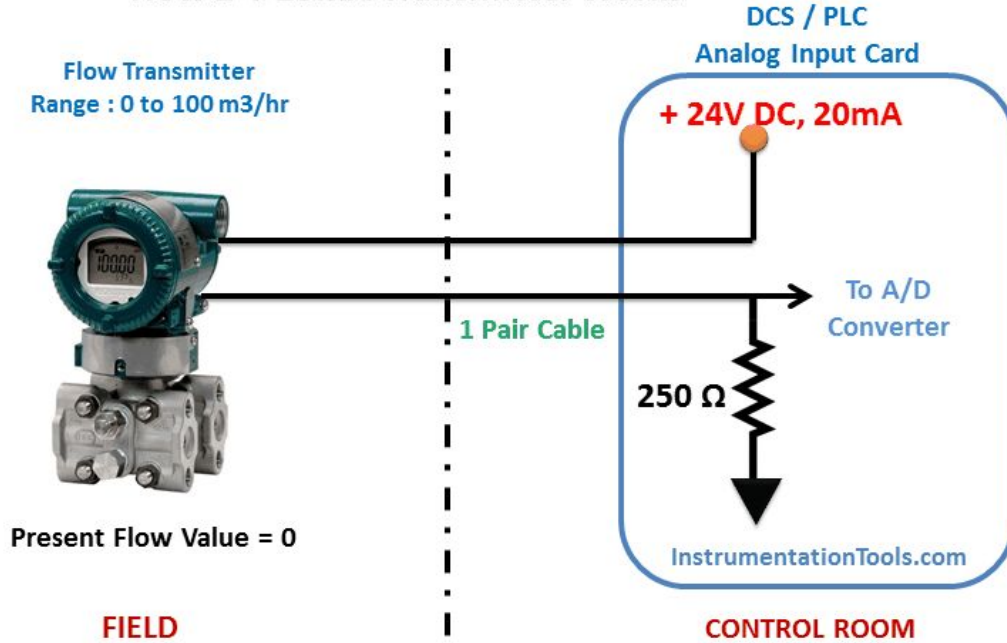

- Voltage
- Current
- Resistance
- Digital

We'll cover a few common measurement applications and how to approach them, many others are similar

- Temperature
- Position/Distance
- Pressure
- Strain (already covered)
- Rotation
- MEMS

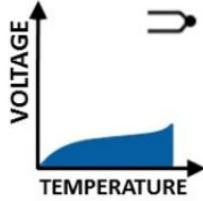
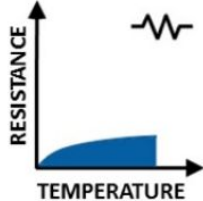
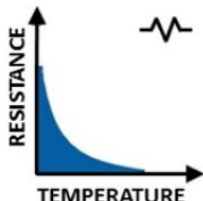

Temperature measurement has many potential technologies

	Advantages	Disadvantages
<p>THERMOCOUPLES</p> 	<ul style="list-style-type: none"> ✓ Simple ✓ Rugged ✓ Inexpensive ✓ No external power ✓ Wide temperature range ✓ Variety of styles 	<ul style="list-style-type: none"> × Nonlinear response × Small sensitivity × Small output voltage × Requires CJC × Least stable
<p>RTD</p> 	<ul style="list-style-type: none"> ✓ Most stable ✓ Good Linearity ✓ Most accurate 	<ul style="list-style-type: none"> × Low sensitivity × Externally powered × Costly × Small output resistance × Self-heating error
<p>THERMISTOR</p> 	<ul style="list-style-type: none"> ✓ Fast ✓ High output ✓ Minimal lead resistance error 	<ul style="list-style-type: none"> × Limited temperature range × Externally powered × Nonlinear × More fragile × Self-heating error

Thermocouples use the Seebeck effect

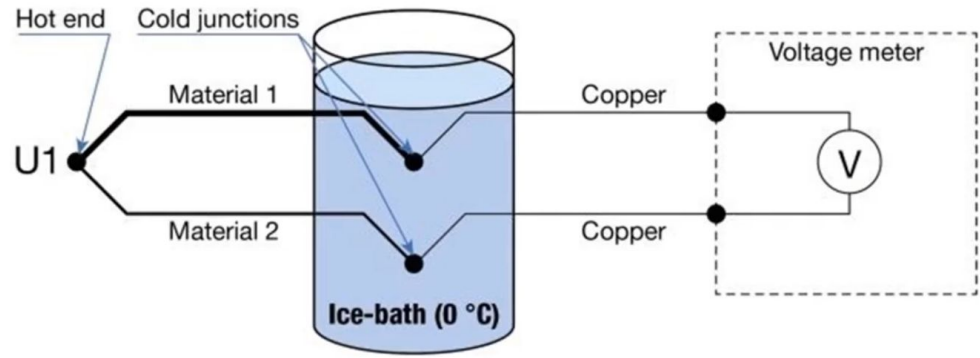
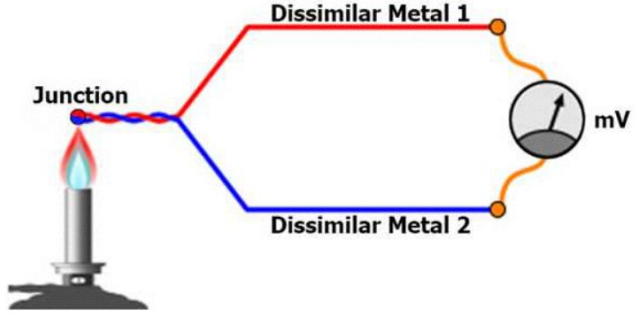

Common Thermocouple Temperature Ranges			
Calibration	Temperature Range	Standard Limits of Error	Special Limits of Error
J	0° to 750°C (32° to 1382°F)	Greater of 2.2°C or 0.75%	Greater of 1.1°C or 0.4%
K	-200° to 1250°C (-328° to 2282°F)	Greater of 2.2°C or 0.75%	Greater of 1.1°C or 0.4%
E	-200° to 900°C (-328° to 1652°F)	Greater of 1.7°C or 0.5%	Greater of 1.0°C or 0.4%
T	-250° to 350°C (-328° to 662°F)	Greater of 1.0°C or 0.75%	Greater of 0.5°C or 0.4%

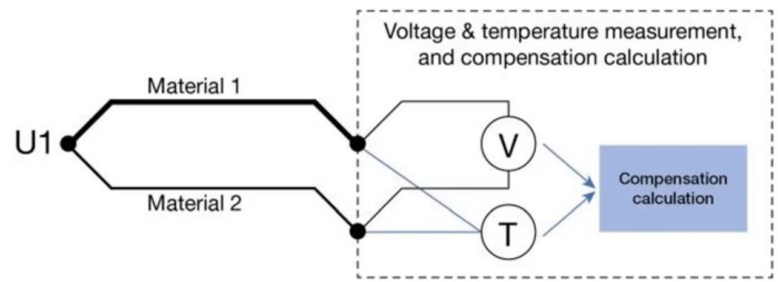

RTDs are resistance based devices with high stability, but low sensitivity

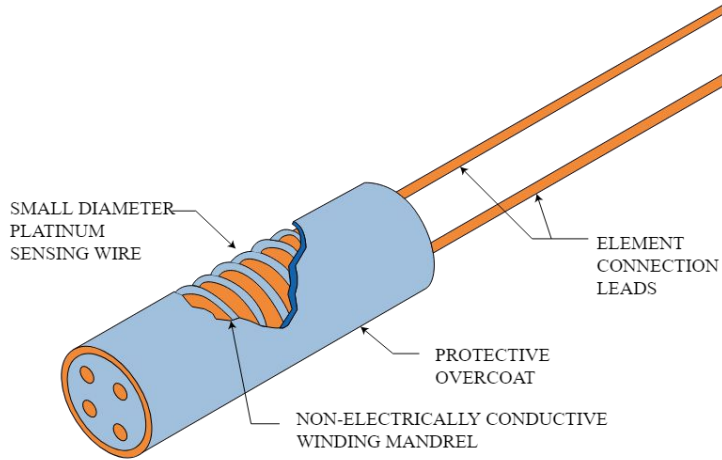

Resistance Temperature Detector (RTD) - 2-Wire,3-Wire,4-Wire Systems

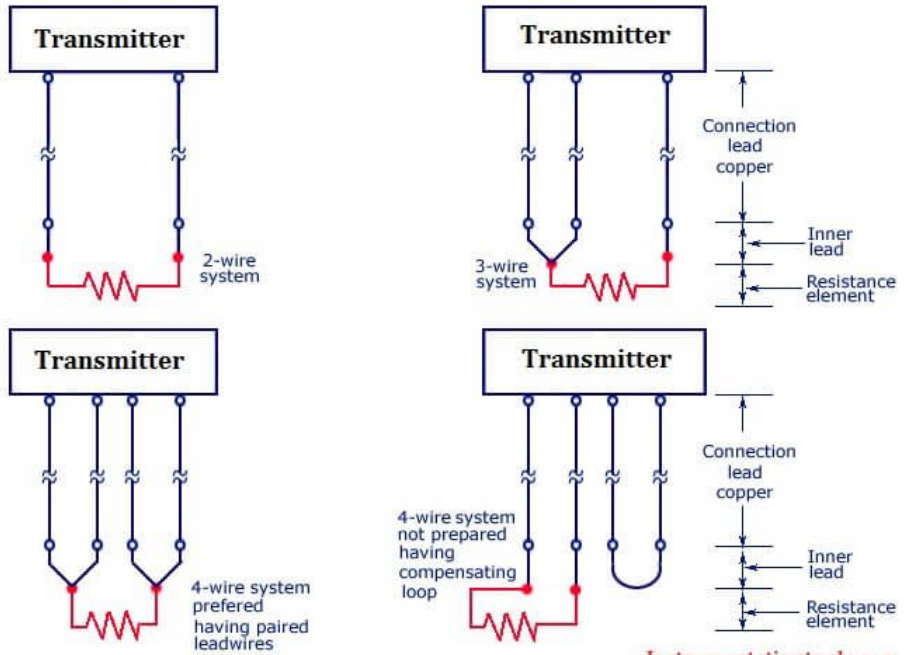

Instrumentationtools.com

Thermistors are inexpensive silicon resistance based devices that are fast, but can experience self heating

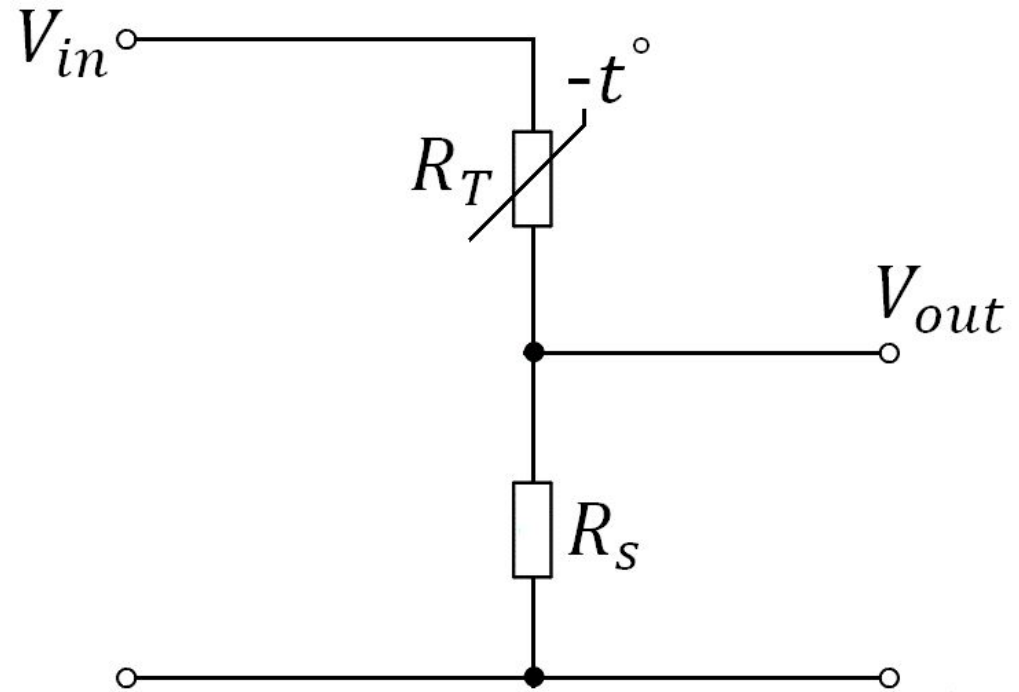
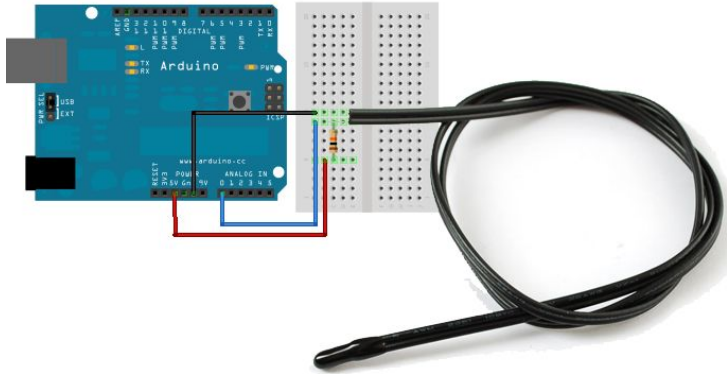

© www.petervis.com

Position/Distance



- DCDTs/LVDTs
- Potentiometers
- Time of Flight
- Laser
- Inductive
- Capacitive

DCDTs and LVDTs are differential transformers, an expensive, but very good displacement sensors

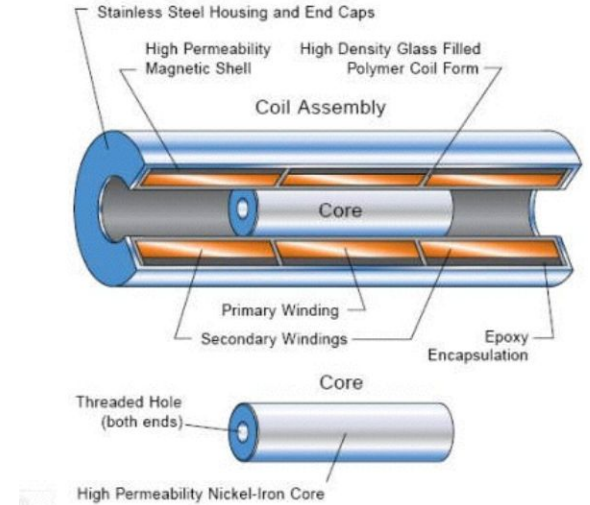
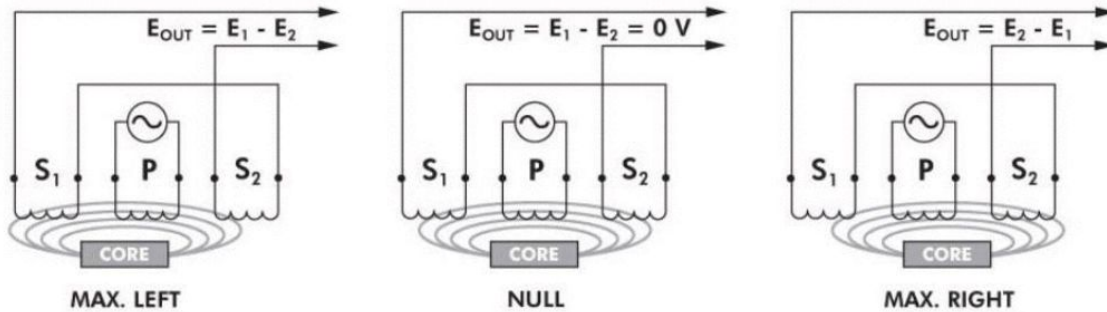

Linear potentiometers can be slightly noisier and more thermally sensitive, but are inexpensive

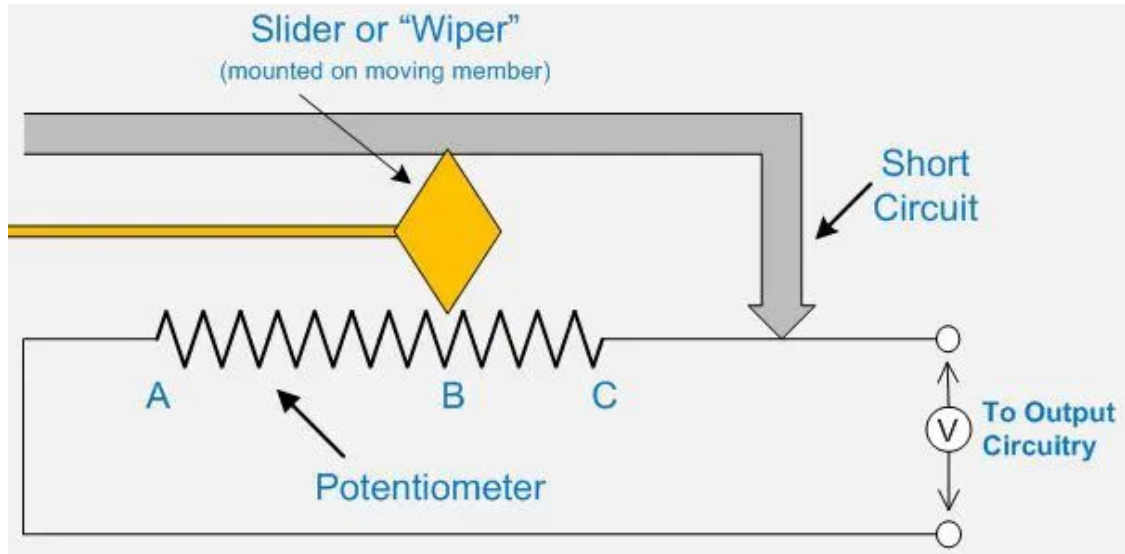

Time of flight sensors are a non-contact method that can be very economical

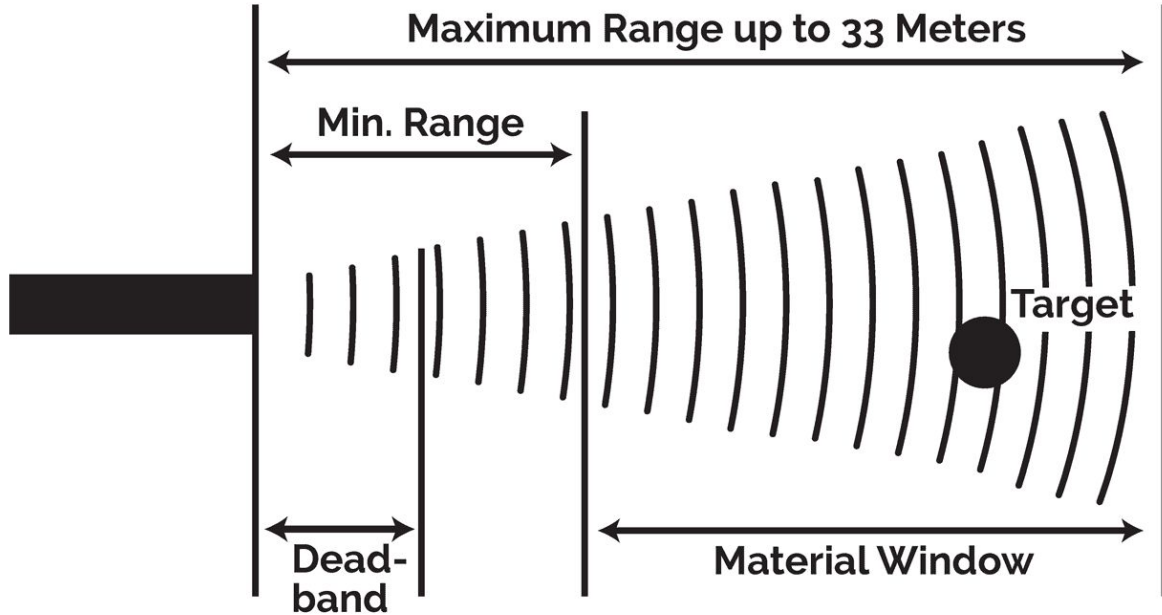

Laser distance sensors are very precise, but expensive



Inductive eddy current sensors are great for conductive non-contact measurements

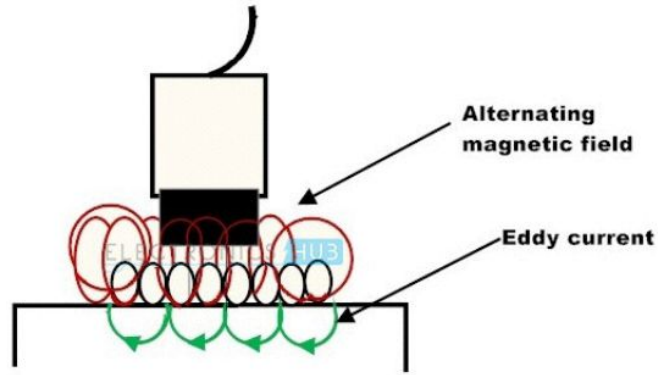

Capacitive sensors are very fast and high resolution sensors

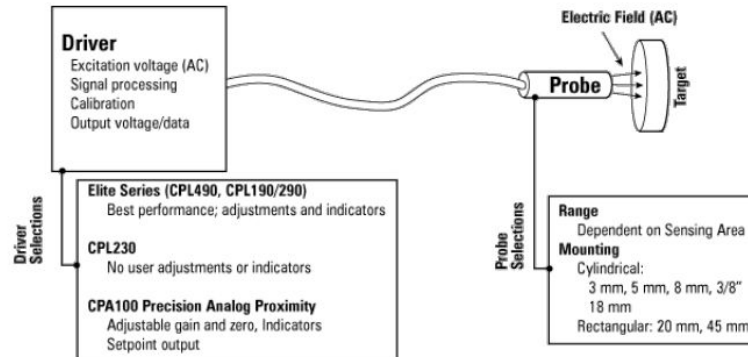
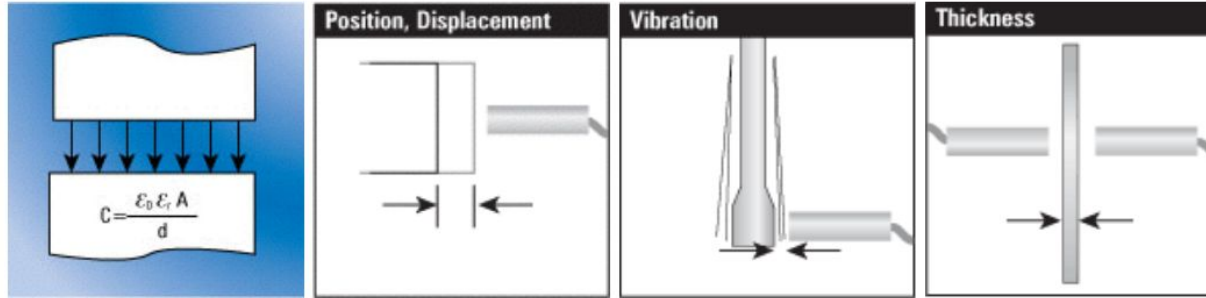

Pressure transducers are generally strain based, but come in multiple reference point variations

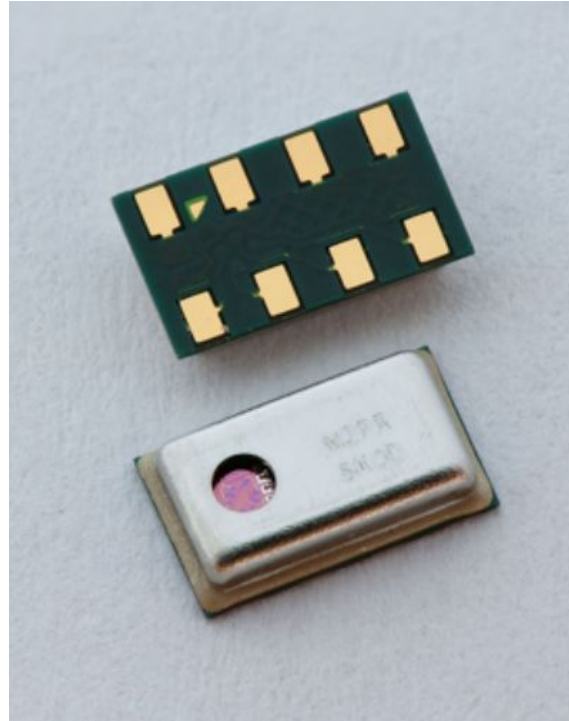

- Absolute
- Gage
- Vacuum
- Differential
- Sealed

Encoders are a great tool for rotary (or what can be translated to rotary) motion

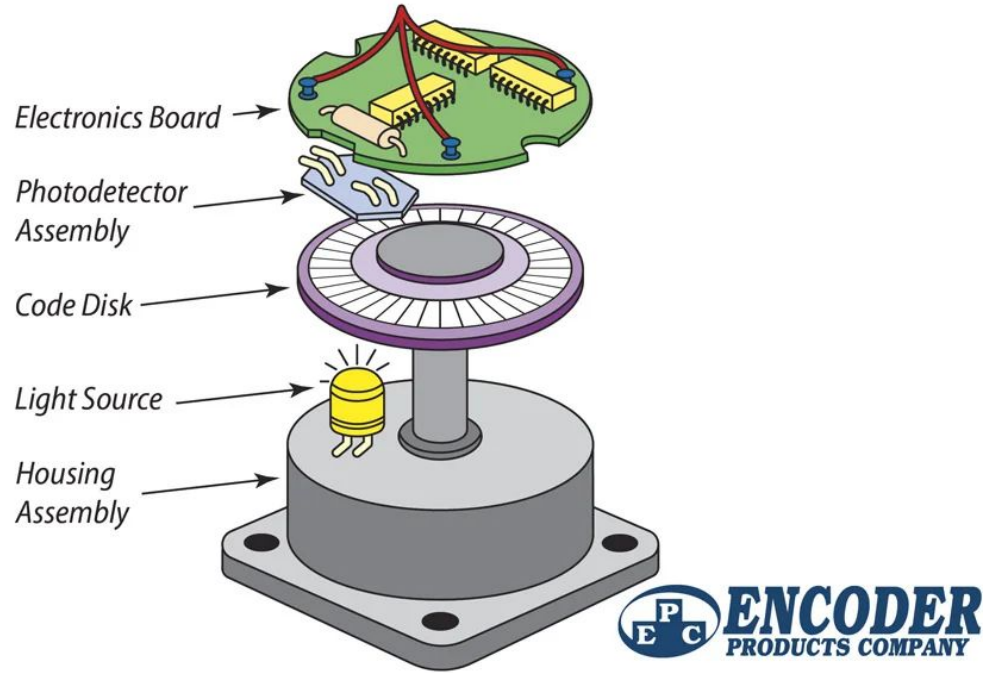

MEMS has slowly been taking over many traditional applications, but the technology is certainly not fully mature

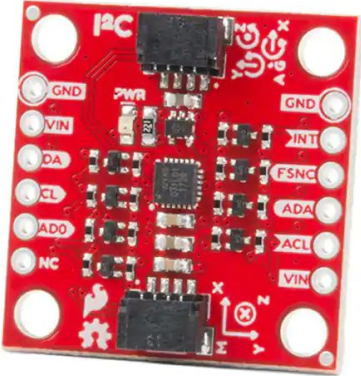
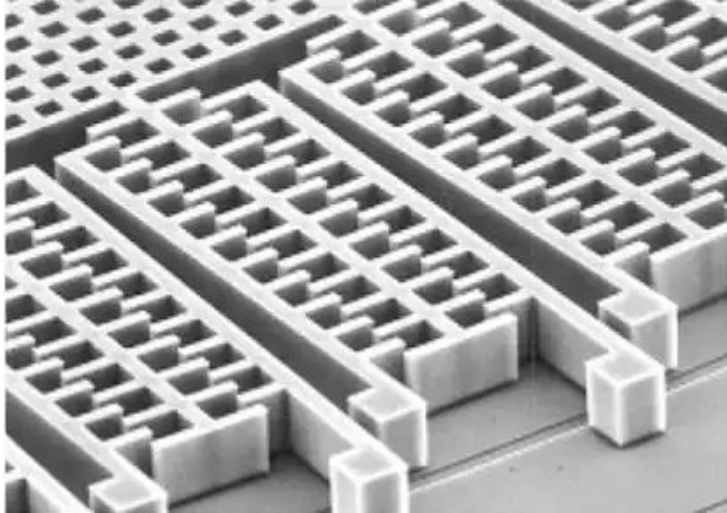
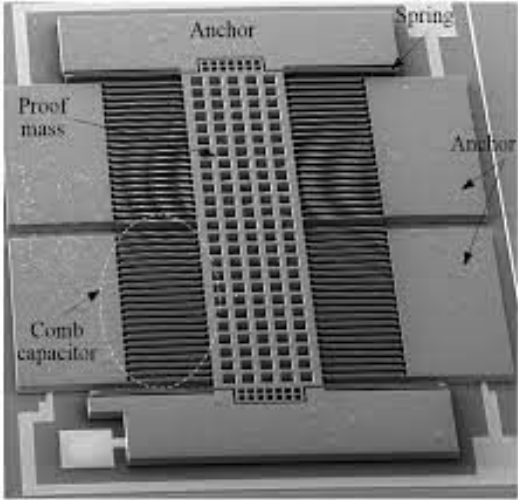

MEMS has slowly been taking over many traditional applications, but the technology is certainly not fully mature

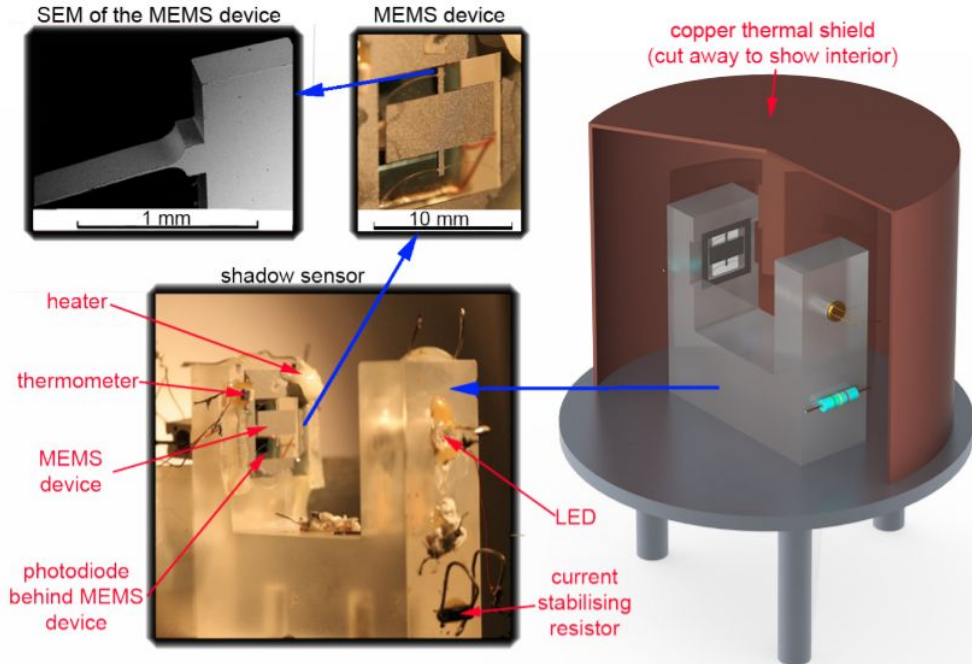
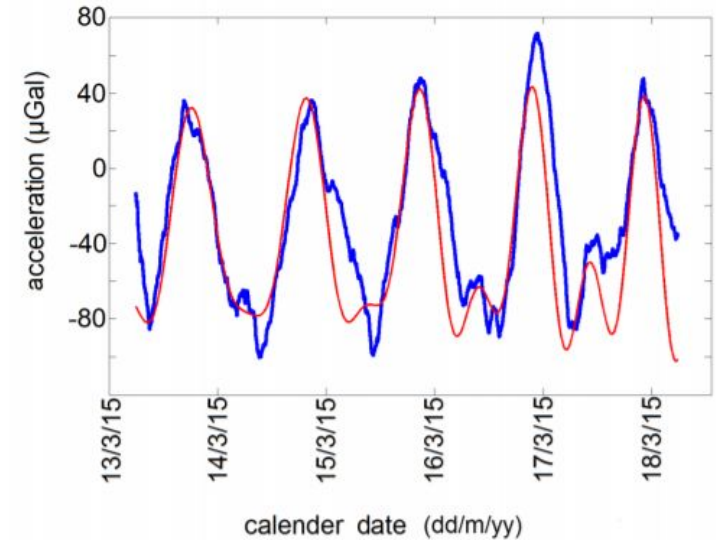

Figure 2



Actuators come in many, many varieties and we're not going to focus on them more than to mention a few of the common ones

